

Panasonic

Advanced Hybrid System

Getting Started

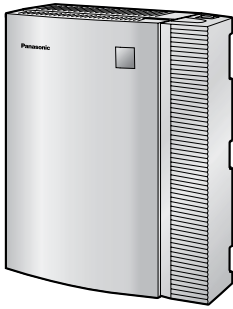

KX-TEA308

Model KX-TEB308



Thank you for purchasing a Panasonic Advanced Hybrid System.
Please read this manual carefully before using this product and save this manual for future use.

System Components

System Components Table

	Model	Description
Main Unit	KX-TEA308	Advanced Hybrid System: 3 Outside (CO) Lines, 8 Hybrid Extensions
	KX-TEB308	Advanced Hybrid System: 3 Outside (CO) Lines, 4 Hybrid and 4 SLT Extensions* ¹
Optional Service Cards	KX-TE82460	2-Port Doorphone Card
	KX-TE82492	2-Channel Voice Message Card (for KX-TEA308 only)
	KX-TE82493	3-Port Caller ID Card
Proprietary Equipment	KX-T30865	Doorphone
	KX-A227	Backup Battery Cable

*¹ Taiwan: 4 PT Extensions

For supported extension types, refer to "2.3 Connecting Extensions".

Notice

Certain models may not be available in your country/area.

Important Safety Instructions

When using your telephone equipment, basic safety precautions should always be followed to reduce the risk of fire, electric shock and injury to persons, including the following:

1. Read and understand all instructions.
2. Follow all warnings and instructions marked on the product.
3. Unplug the product from the wall outlet before cleaning. Do not use liquid cleaners or aerosol cleaners. Clean with a damp cloth.
4. Do not use this product near water, for example, near a bathtub, wash bowl, kitchen sink, or laundry tub, in a wet basement, or near a swimming pool.
5. Do not place the product on an unstable surface, as a fall may cause serious internal damage.
6. Slots and openings in the front, back and bottom of the cabinet are provided for ventilation; to protect it from overheating, these openings must not be blocked or covered. The openings should never be blocked by placing the product on a bed, sofa, rug, or other similar surface while in use. The product should never be placed near or over a radiator or other heat source. This product should not be placed in a sealed environment unless proper ventilation is provided.
7. The product should only be connected to the type of electrical power supply specified on the product label. If you are not sure of the type of power supply to your home, consult your dealer or local power company.
8. For safety purposes this unit is equipped with an earthed plug. If you do not have an earthed outlet, please have one installed. Do not bypass this safety feature by tampering with the plug.
9. Do not allow anything to rest on the power cord. Do not locate this product where the power cord may be stepped on or tripped on.
10. To reduce the risk of fire or electric shock, do not overload wall outlets and extension cords.
11. Do not insert objects of any kind into this product through its slots and openings, as they may touch dangerous voltage points or short out parts that could result in a risk of fire or electric shock. Never spill liquid of any kind on or in the product.
12. To reduce the risk of electric shock, do not disassemble this product. Only qualified personnel should service this product. Opening or removing covers may expose you to dangerous voltages or other risks. Incorrect reassembly can cause electric shock.
13. Unplug this product from the wall outlet and have it serviced by qualified service personnel in the following cases:
 - a) When the power supply cord or plug is damaged or frayed.
 - b) If liquid has been spilled into the product.
 - c) If the product has been exposed to rain or water.
 - d) If the product does not operate according to the operating instructions. Adjust only the controls that are explained in the operating instructions. Improper adjustment of other controls may result in damage and may require service by a qualified technician to restore the product to normal operation.
 - e) If the product has been dropped or the cabinet has been damaged.
 - f) If product performance deteriorates.
14. Avoid using wired telephones during an electrical storm. There is a remote risk of electric shock from lightning.
15. Do not use a telephone in the vicinity of a gas leak to report the leak.

-
16. Keep the unit away from heating appliances and devices that generate electrical noise such as fluorescent lamps, motors and televisions. These noise sources can interfere with the performance of the PBX.
 17. This unit should be kept free of dust, moisture, high temperature (more than 40 °C) and vibration, and should not be exposed to direct sunlight.
 18. If you are having problems making calls to outside destinations, follow this procedure to test the outside (CO) lines:
 1. Disconnect the PBX from all outside (CO) lines.
 2. Connect known working single line telephones (SLTs) to those outside (CO) lines.
 3. Make a call to an external destination using those SLTs.If a call cannot be carried out correctly, there may be a problem with the outside (CO) line that the SLT is connected to. Contact your telephone company.
If all SLTs operate properly, there may be a problem with your PBX. Do not reconnect the PBX to the outside (CO) lines until it has been serviced by an authorised Panasonic Factory Service Centre.
 19. Wipe the unit with a soft cloth. Do not clean the unit with abrasive powders or with chemical agents such as benzene or thinner.

For users in New Zealand only

- This equipment shall not be set to make automatic calls to the Telecom '111' Emergency Service.
- The grant of a Telepermit for any item of terminal equipment indicates only that Telecom has accepted that the item complies with minimum conditions for connection to its network. It indicates no endorsement of the product by Telecom, nor does it provide any sort of warranty. Above all, it provides no assurance that any item will work correctly in all respects with another item of Telepermitted equipment of a different make or model, nor does it imply that any product is compatible with all of Telecom's network services.
- This equipment is not capable, under all operating conditions, of correct operation at the higher speeds for which it is designed. Telecom will accept no responsibility should difficulties arise in such circumstances.
- Some parameters required for compliance with Telecom's Telepermit requirements are dependent on the equipment (PBX) associated with this modem. In order to operate within the limits for compliance with Telecom's Specifications, the associated PBX equipment shall be set to ensure that modem calls are answered between 3 and 30 seconds of receipt of ringing.
- **IMPORTANT NOTICE**
Under power failure conditions, the connected telephones may not operate. Please ensure that a separate telephone, not dependent on local power, is available for emergency use.

For users in Australia only

- No External TRC Terminal is provided due to an Internal Link between PE and TRC.

For users in Taiwan only

- Lithium batteries can be found in the circuit boards of the main board and optional cards of the PBX.

Notes

- When disposing of any of the above products, all batteries must be removed. Follow the applicable laws, regulations, and guidelines in your country/area regarding disposal of batteries.
- When replacing a battery, use only the same battery type, or an equivalent recommended by the battery manufacturer.

Notice

Regarding removing or replacing a battery in the circuit board, consult your dealer.



廢電池請回收

For users in Finland, Norway and Sweden only

- This unit may only be installed in a room or space with restricted access, and equipotential bonding must be applied. For information on earthing, refer to "2.7 Connecting Frame Earth".

WARNING

- **THIS UNIT MAY ONLY BE INSTALLED AND SERVICED BY QUALIFIED SERVICE PERSONNEL.**
- **IF DAMAGE TO THE UNIT EXPOSES ANY INTERNAL PARTS, DISCONNECT THE POWER SUPPLY CORD IMMEDIATELY AND RETURN THE UNIT TO YOUR DEALER.**
- **UNPLUG THIS UNIT FROM THE AC OUTLET IF IT EMITS SMOKE, AN ABNORMAL SMELL OR MAKES UNUSUAL NOISE. THESE CONDITIONS CAN CAUSE FIRE OR ELECTRIC SHOCK. CONFIRM THAT SMOKE HAS STOPPED AND CONTACT AN AUTHORISED PANASONIC FACTORY SERVICE CENTRE.**
- **WHEN RELOCATING THE EQUIPMENT, FIRST DISCONNECT THE TELECOM CONNECTION BEFORE DISCONNECTING THE POWER CONNECTION. WHEN THE UNIT IS INSTALLED IN THE NEW LOCATION, RECONNECT THE POWER FIRST, AND THEN RECONNECT THE TELECOM CONNECTION.**
- **TO PREVENT POSSIBLE FIRE OR ELECTRIC SHOCK, DO NOT EXPOSE THIS PRODUCT TO RAIN OR MOISTURE.**
- **THE POWER SUPPLY CORD IS USED AS THE MAIN DISCONNECT DEVICE. ENSURE THAT THE AC OUTLET IS LOCATED NEAR THE EQUIPMENT AND IS EASILY ACCESSIBLE.**

CAUTION



DANGER OF EXPLOSION EXISTS IF A BATTERY IS INCORRECTLY REPLACED. REPLACE ONLY WITH THE SAME OR EQUIVALENT TYPE RECOMMENDED BY THE BATTERY MANUFACTURER. DISPOSE OF USED BATTERIES ACCORDING TO THE MANUFACTURER'S INSTRUCTIONS.

SAVE THESE INSTRUCTIONS

Precautions for Users in the United Kingdom

FOR YOUR SAFETY, PLEASE READ THE FOLLOWING TEXT CAREFULLY.

This appliance is supplied with a moulded three-pin mains plug for your safety and convenience. A 5 amp fuse is fitted in this plug. Should the fuse need to be replaced, please ensure that the replacement fuse has a rating of 5 amps and that it is approved by ASTA or BSI to BS1362.

Check for the ASTA mark  or the BSI mark  on the body of the fuse.

If the plug contains a removable fuse cover, you must ensure that it is refitted when the fuse is replaced. If you lose the fuse cover, the plug must not be used until a replacement cover is obtained. A replacement fuse cover can be purchased from your local Panasonic dealer.

IF THE FITTED MOULDED PLUG IS UNSUITABLE FOR THE AC OUTLET IN YOUR PREMISES, THEN THE FUSE SHOULD BE REMOVED AND THE PLUG CUT OFF AND DISPOSED OF SAFELY. THERE IS A DANGER OF SEVERE ELECTRICAL SHOCK IF THE CUT-OFF PLUG IS INSERTED INTO ANY 13 AMP OUTLET.

If a new plug is to be fitted, please observe the wiring code as shown below. If in any doubt, please consult a qualified electrician.

WARNING

THIS APPLIANCE MUST BE EARTHED.

IMPORTANT: The wires in the mains lead are coloured as follows:

Green-and-yellow: Earth

Blue: Neutral

Brown: Live

As the colours of the wires in the mains lead of this apparatus may not correspond with the coloured markings identifying the terminals in your plug, proceed as follows.

The wire that is coloured GREEN-AND-YELLOW must be connected to the terminal in the plug that is marked with the letter E or by the safety earth symbol  or coloured GREEN or GREEN-AND-YELLOW.

The wire that is coloured BLUE must be connected to the terminal that is marked with the letter N or coloured BLACK.

The wire that is coloured BROWN must be connected to the terminal that is marked with the letter L or coloured RED.

How to replace the fuse: Open the fuse compartment with a screwdriver and replace the fuse and fuse cover.

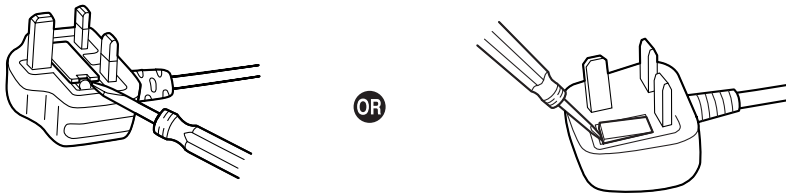

The equipment must be connected to direct extension lines, and a payphone should not be connected as an extension.

999 and 112 can be dialled on the apparatus after accessing the Exchange line for the purpose of making outgoing calls to the BT emergency services.

During dialling, this apparatus may tinkle the bells of other telephones using the same line. This is not a fault and we advise you not to call Fault Repair Service.

Table of Contents

1	Before Installation	9
1.1	Unpacking.....	9
1.2	System Connection Diagram	10
2	Installation.....	11
2.1	Opening Covers	11
2.2	Connecting Outside (CO) Lines.....	11
2.3	Connecting Extensions	12
2.4	Securing the Cables.....	13
2.5	Closing Covers	14
2.6	Wall Mounting.....	15
2.6.1	Mounting on a Wooden Wall	15
2.6.2	Mounting on a Concrete or Mortar Wall	16
2.7	Connecting Frame Earth	17
3	Starting the Advanced Hybrid System	19
3.1	Starting the Advanced Hybrid System.....	19
4	PC Programming	21
4.1	PC Programming.....	21
5	PT Programming.....	22
5.1	Programming Instructions	22
5.2	Programming Procedures	23
5.2.1	Basic Features	26
5.2.2	Toll Restriction (TRS) Features	30

1 Before Installation

1.1 Unpacking

Check the package contents.

Main Unit × 1

CD-ROM (including manuals, etc.) × 1



*AC Cord × 1

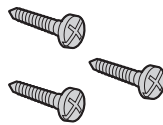

Screw × 3



Washer × 3



Mini Plug (for pager and music source) × 2

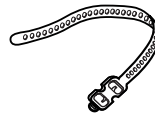

Strap × 1

* The type of the AC cord may vary depending on the country/area of use.
More than one type of AC cord may be included for countries/areas in Central and South America.

Necessary tools (not supplied):

✓ Telephone cable for extension connection:

Diameter of cable (\varnothing 0.4 mm to \varnothing 0.6 mm)	Maximum length of cable
\varnothing 0.5 mm	1128 m for SLT
\varnothing 0.5 mm	229 m for PT and DSS Console

The maximum length of the cable may vary depending on the type of the cables.

- ✓ 2-conductor connectors for outside (CO) line connections
- ✓ 4-conductor connectors for extension connections
- ✓ Hammer × 1
- ✓ KX-T7730 or KX-T7735 × 1
- ✓ Screwdriver × 1

Note

Use a twisted pair cable for 2- or 4-conductor connector.

1.2 System Connection Diagram

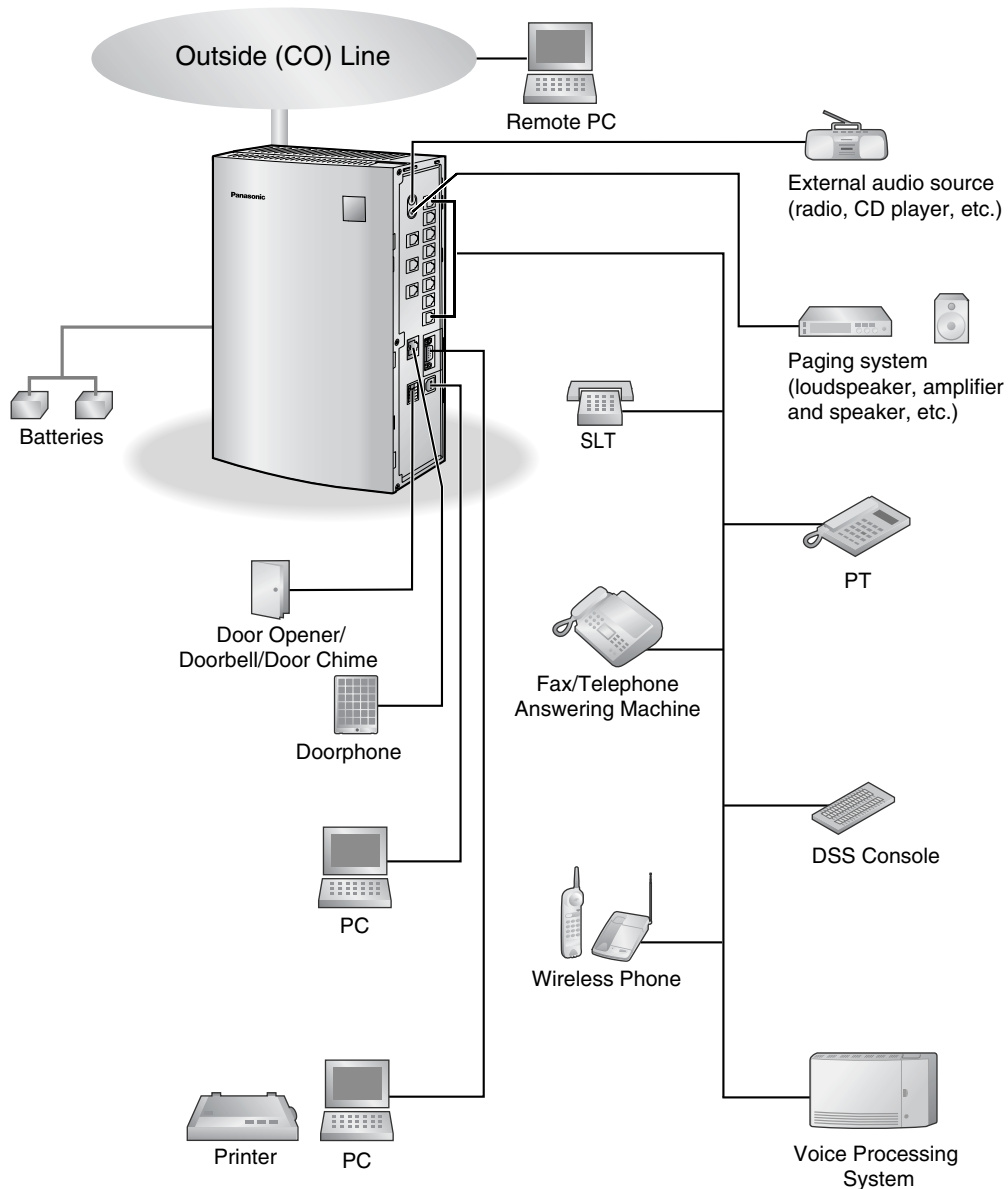

- Connect a display-equipped proprietary telephone (PT) to extension jack 01, as this extension is automatically designated as the manager extension.
- For supported extension types, refer to "2.3 Connecting Extensions".

2 Installation

2.1 Opening Covers

1. Pull the slide button to the right and, holding it, slide the cable cover upwards. Then turn the cable cover slightly to remove it.

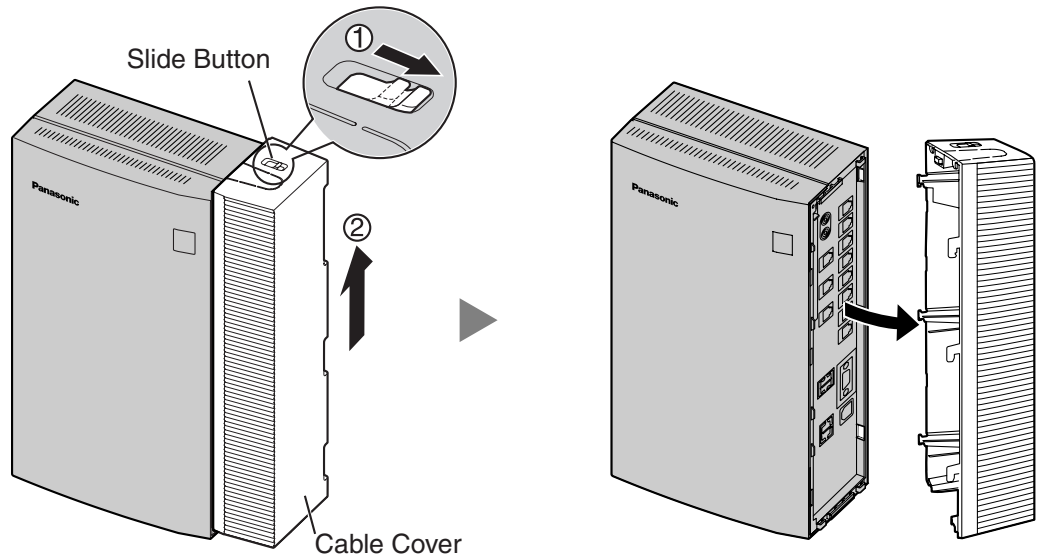

2.2 Connecting Outside (CO) Lines

1. Insert the modular plugs of the telephone line cords (2-conductor wiring) into the outside (CO) line jacks.
2. Connect the line cords to the terminal board or the modular jacks from the telephone company.

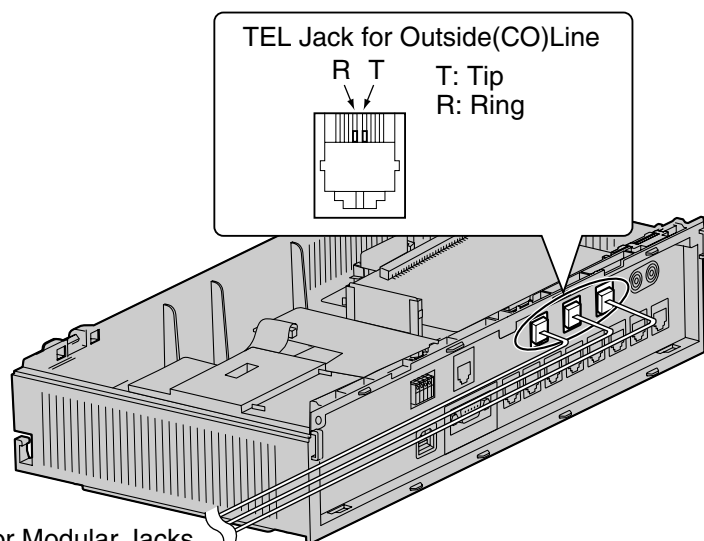

2.3 Connecting Extensions

Extension jacks can be used for proprietary telephones (PTs), Direct Station Selection (DSS) Consoles, single line telephones (SLTs), and Voice Processing Systems.

Notes

- Connect a display-equipped proprietary telephone (PT) to extension jack 01, as this extension is automatically designated as the manager extension.
- For KX-TEB308, 4 extension jacks out of 8 can be used for SLTs*¹ only. The following table shows the extension jack types.

Extension Jack Types

	TEA308	TEB308	TEB308TW
Hybrid (PT/SLT)	Jack01-08	Jack01-04	Jack01-04
SLT only	—	Jack05-08	—
PT only	—	—	Jack05-08

Insert the modular plugs of the telephone line cords (2- or 4-conductor wiring) into the modular jacks on the PBX.

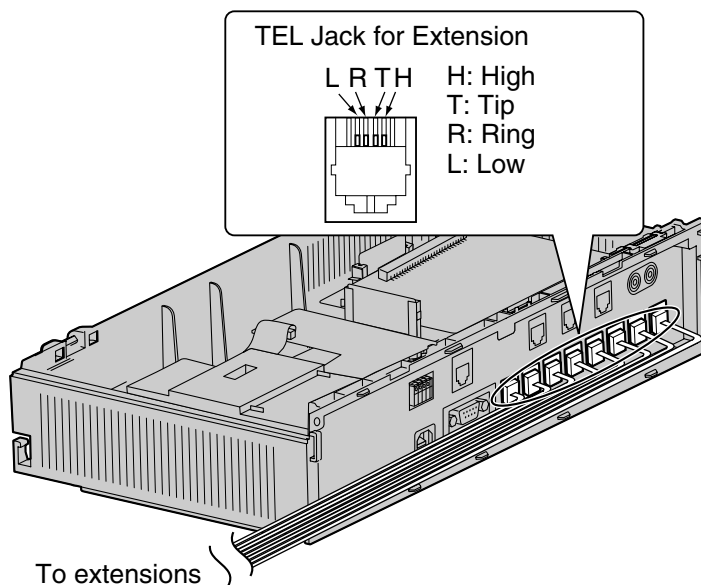

*¹ Taiwan: PTs

2.4 Securing the Cables

1. Attach the included strap to either of the 2 rails depending on your preference.

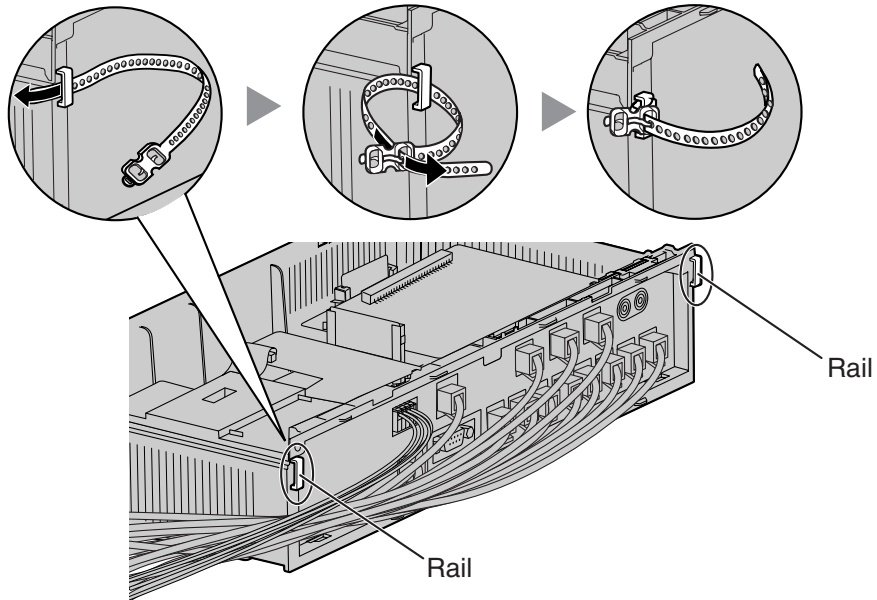

2. Bind the cables as shown.

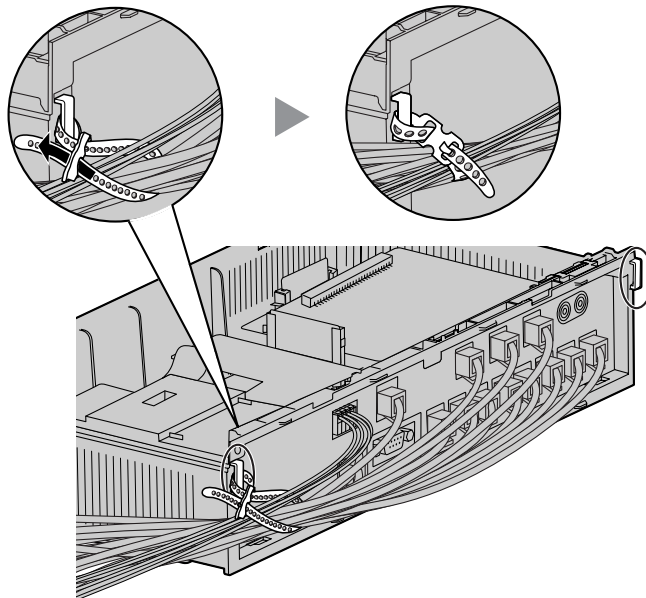

2.5 Closing Covers

1. Attach the rear hooks on the cable cover to the main unit, then swing the cable cover closed so that the front hooks fit in place.

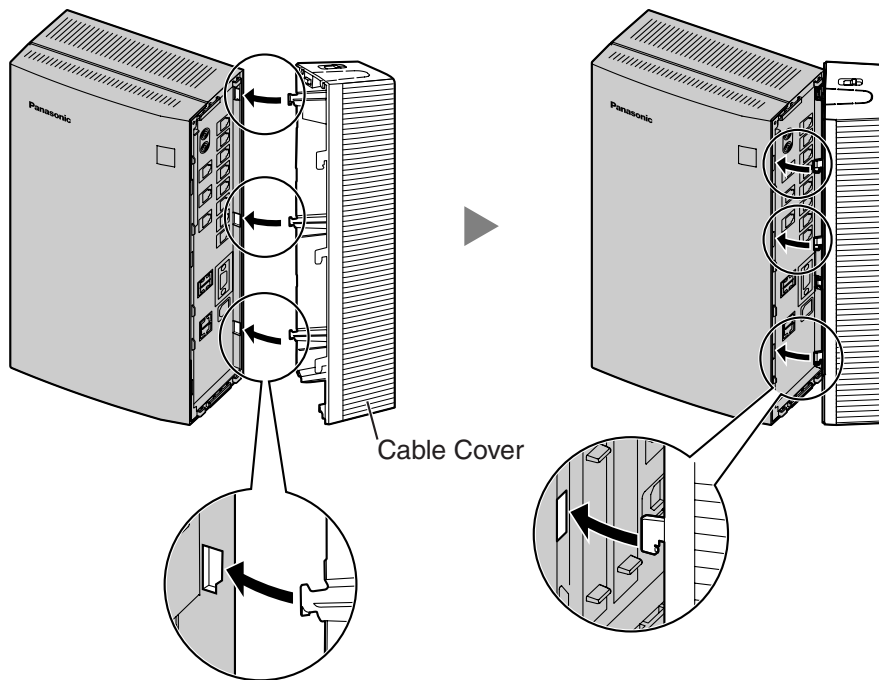

2. Slide the cable cover down until it locks.

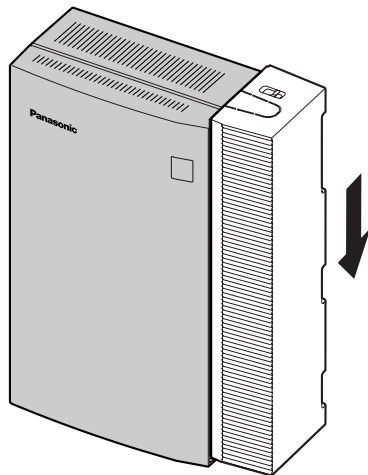

Note

For safety reasons, keep the front cover closed while the PBX is in operation.

2.6 Wall Mounting

The PBX is designed for wall mounting only. The wall where the PBX is to be mounted must be able to support the weight of the PBX. When wall mounting the main unit, use either the included screws, or screws of the same size.

2.6.1 Mounting on a Wooden Wall

The included screws may be used when mounting the main unit on a wooden wall.

1. Place the template (found on the last page of this manual) on the wall to mark the 3 screw positions.

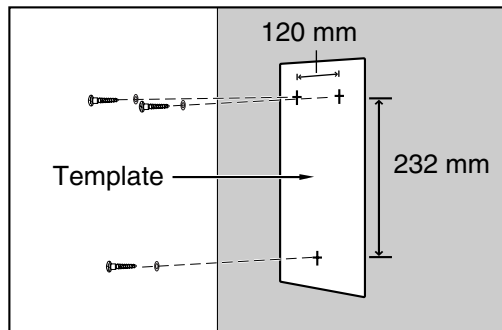

2. Fit the washers on the screws, and drive the screws into the wall.

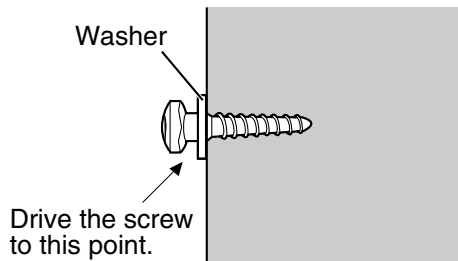

3. Affix the PBX to the screw heads.

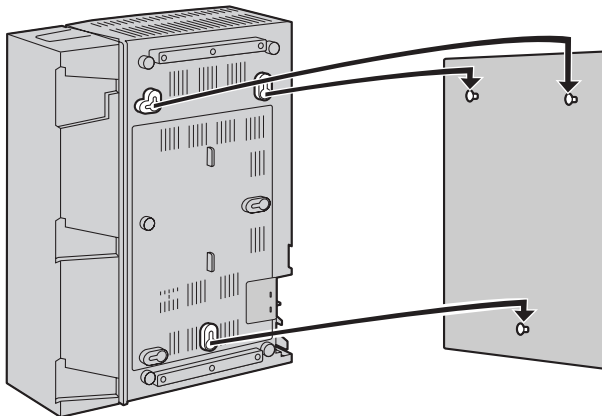

Notes

- Do not block the openings of the cabinet. Leave at least 20 cm of space above and 10 cm to the sides of the PBX for ventilation.
- Make sure that the wall behind the cabinet is flat and free of obstacles, so that the openings on the back of the cabinet will not be blocked.
- Be careful not to drop the cabinet.

2.6.2 Mounting on a Concrete or Mortar Wall

The included screws may be used when mounting the main unit on a concrete or mortar wall. User-supplied anchor plugs are also necessary.

1. Place the template (found on the last page of this manual) on the wall to mark the 3 screw positions.

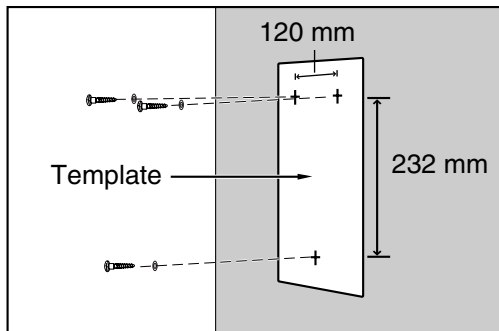

2. Drill holes in the wall as marked and fit the anchor plugs (not included) into the holes.

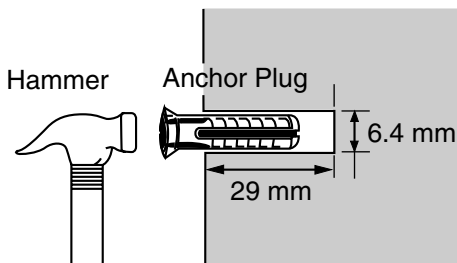

3. Fit the washers on the screws, and drive the screws into the anchor plugs.

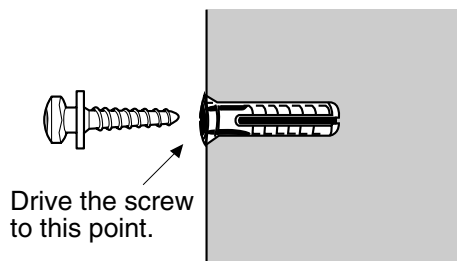

-
- Affix the PBX to the screw heads.

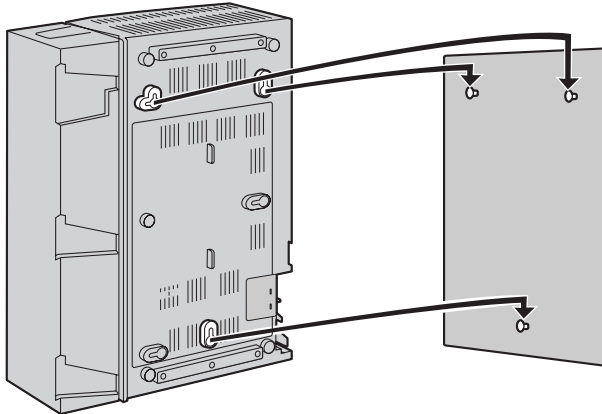

Notes

- Do not block the openings of the cabinet. Leave at least 20 cm of space above and 10 cm to the sides of the PBX for ventilation.
- Make sure that the wall behind the cabinet is flat and free of obstacles, so that the openings on the back of the cabinet will not be blocked.
- Be careful not to drop the cabinet.

2.7 Connecting Frame Earth

IMPORTANT

Connect the frame of the PBX to earth.

- Loosen the screw.
- Insert an earthing wire (user-supplied)*.
- Tighten the screw.
- Connect the earthing wire to earth.

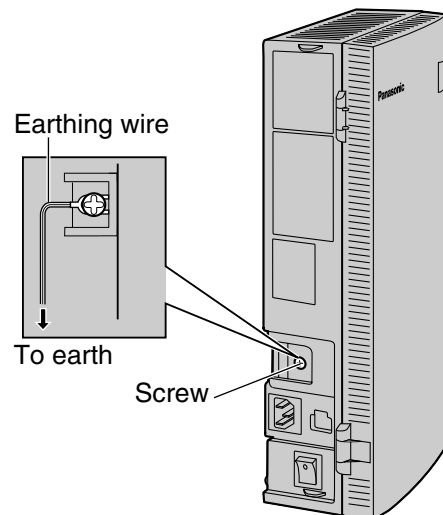

* Use an earthing wire that has a conductor with a cross-sectional area of at least 0.75 mm² or 18 AWG. Green-and-yellow insulation is required.

-
- Be sure to comply with all applicable laws, regulations, and guidelines.
 - Proper earthing is very important to protect the PBX from external noise and to reduce the risk of electrocution in the event of a lightning strike.
 - The AC cable's earthing pin may not be enough to protect the PBX from external noise and lightning strikes. A permanent connection must be made between earth and the earth terminal of the main unit.

3 Starting the Advanced Hybrid System

3.1 Starting the Advanced Hybrid System

This section explains the procedure for starting the PBX for the first time, with default values, or when you wish to re-initialise the PBX.

1. Make sure that all outside (CO) lines you use are connected to the PBX.
2. Set the Power Switch to the "OFF" position.
3. Connect the AC cord to the PBX, then plug the AC cord into an AC outlet.
4. Set the Power Switch to the "ON" position.

Note

For safety reasons, do not stretch, bend, or pinch the AC cord.

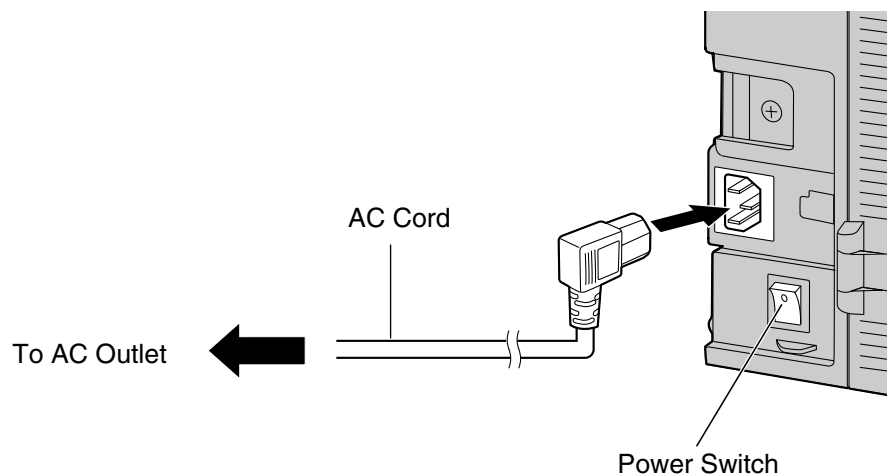

5. Perform the following operation with a proprietary telephone (PT) connected to JACK 01.
 - a. Press the PROGRAM button.
 - b. Press * #.
 - c. Enter 1234.
 - d. Enter 999.
 - e. Press the NEXT (SP-PHONE) button.
 - f. Press the SELECT (AUTO ANS/MUTE) button until "All Para" is displayed.
 - g. Press the STORE (AUTO DIAL/STORE) button.
 - h. Press the END (HOLD) button.
 - i. Press the PROGRAM button.
 - The PBX will be initialised with the default values. The type of outside (CO) lines is automatically detected.

CAUTION

- The PBX is powered as long as the AC cord is plugged into an AC outlet, even if the Power Switch is set to the "OFF" position.
- The power supply cord is used as the main disconnect device. Ensure that the AC outlet is located/installed near the equipment and is easily accessible.

Notes

- If the outside (CO) lines you use are not connected to the PBX, outside (CO) line type can not be automatically detected.
- Use only the AC cord included with the PBX.
- If the PBX will not be used for an extended period of time, set the Power Switch to the "OFF" position and disconnect the AC cord from the AC outlet to conserve power.

4 PC Programming

4.1 PC Programming

PBX features and settings can be customised using a PC and the KX-TE308 Maintenance Console software. Customisation and maintenance can be done easily and efficiently using Windows-based PC programming software, with graphical icons to guide you.

Programming can be performed both on-site, using a PC connected directly to the PBX, and off-site, by accessing the PBX via modem. This allows settings to be changed quickly to meet users' needs, locally or remotely.

PBX settings can be downloaded from the PBX to a PC. The saved data can act as a backup, to protect against unexpected loss of PBX setting data.

Refer to the Installation Manual included on the CD-ROM to install and start KX-TE308 Maintenance Console.

System Requirements

Operating System

- Microsoft® Windows® 98 SE, Windows Me, Windows 2000, or Windows XP

Hardware

- CPU: 300 MHz Intel® Celeron® or faster
- RAM: At least 128 megabytes (MB) of available RAM
- Hard disk space: At least 100 MB of space for the installation, and approximately 2 MB of additional space for user files.

5 PT Programming















5.1 Programming Instructions



The PBX can be programmed by entering 3-digit programming numbers with a PT. In this manual, how to programme some features through PT is explained.

Required Telephone

PBX settings can be customised through system programming by using a proprietary telephone (PT) with a display, such as the KX-T7730. Connect the PT to the extension jack 01 to access system programming.

Buttons and Functions

Fixed Button (KX-T7730/KX-T7735)	Function
	PREV (PREVIOUS)
	NEXT
	
	 , 
	 , 
	SECRET
	STORE
	PAUSE
	PROGRAM
	END

Fixed Button (KX-T7730/KX-T7735)	Function
<small>AUTO ANS</small>  <small>MUTE</small>	SELECT
<small>FLASH/RECALL</small> 	FLASH
<small>TRANSFER</small> 	CLEAR

Entering System Programming Mode

To enter system programming mode, the system password is required.

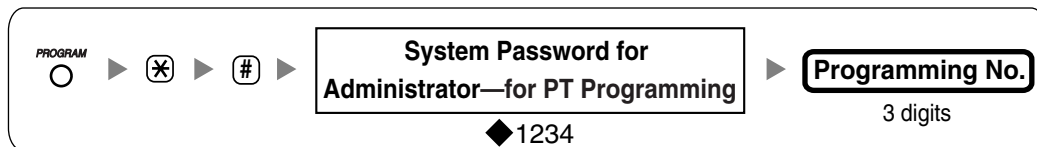

Note

- ◆ means default value throughout these programming instructions.

5.2 Programming Procedures

Notes

- ◆ means default value throughout these programming instructions.
- * means to select "All" throughout these programming instructions.
- The following are displayed when you store a number, such as a telephone number, or feature number:
 P: PAUSE; -: CONF; F: FLASH/RECALL; []: INTERCOM
 x: PAUSE (substitutes for any number [i.e., wild card])
- To return to the previous programming item, press ◀.
- To correct a wrong entry, press CLEAR and then enter the new input.
- To delete a stored parameter, press CLEAR, enter the new input, and then press STORE.
- Press ◀ or ▶ to scroll the display.
- Some programmes cannot have a value left empty.

The PT's dialling buttons can be used to enter characters when storing a name or message. The following tables depict the available characters:

Table 1 (Alphabet mode)/Table 2 (Numeral mode)

Buttons \ Times	Times								Buttons \ Times	Times
	1	2	3	4	5	6	7	8		1
1	!	?	"							1
2	A	B	C	a	b	c				2
3	D	E	F	d	e	f				3
4	G	H	I	g	h	i				4
5	J	K	L	j	k	l				5
6	M	N	O	m	n	o				6
7	P	Q	R	S	p	q	r	s		7
8	T	U	V	t	u	v				8
9	W	X	Y	Z	w	x	y	z		9
0	(Space)	.	,	'	:	;				0
*	/	+	-	=	<	>				*
□	\$	%	&	@	()				□

Table 3 (Cyrillic alphabet mode for RU [Russia]/UA [Ukraine] model)

Buttons	Times									
	1	2	3	4	5	6	7	8	9	10
1	А	Б	В	!	?	"				
2	Г	Д	Е	Ё						
3	Ж	З	И	Й						
4	К	Л	М							
5	Н	О	П							
6	Р	С	Т							
7	У	Ф	Х							
8	Ц	Ч	Ш							
9	Щ	Ъ	Ы	Ь						
0	Э	Ю	Я	(Space)	.	,	'	:	;	
*	/	+	-	=	<	>	Г*	Є*	І*	İ*
□	\$	%	&	@	()	€*	І*	Ÿ*	

* This character is only available for the KX-T7735RU.

[Example of Entering Characters]

To enter "Ann":

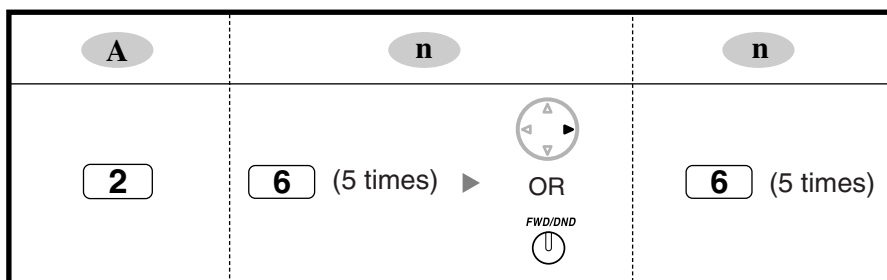

Notes

- To toggle between "Alphabet mode" and "Numeral mode" or between "Alphabet mode", "Cyrillic alphabet mode (assignable only in Extension Name in Cyrillic [616])", and "Numeral mode", press SELECT.
- To move the cursor right, press ►.
- To delete all characters, press CLEAR. To delete a character, press ◀.

5.2.1 Basic Features

Date & Time [000]

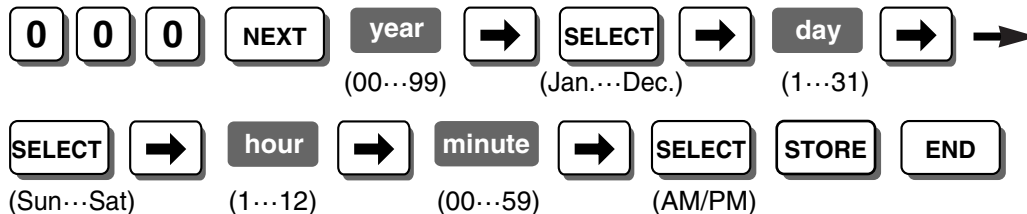

Notes

- The clock starts immediately after the STORE button is pressed.
- The PBX supports years from 2004 to 2099.

System Speed Dialling Number [001]

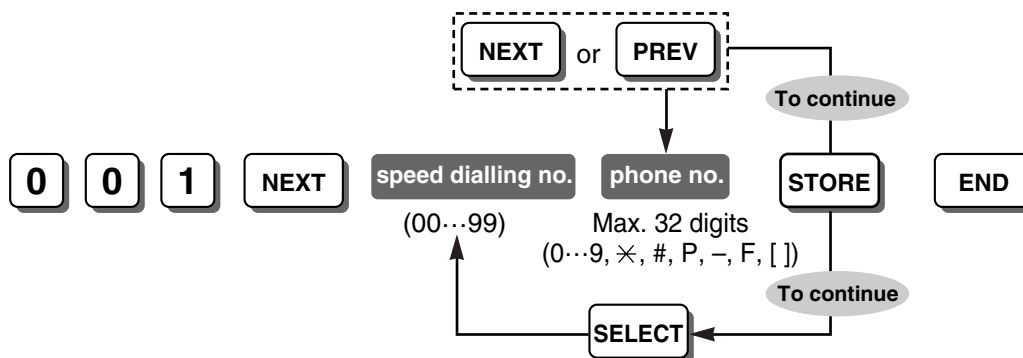

Note

An Outside (CO) Line Access number (9/0 [for New Zealand: 1 or 9], 81 through 83) should be included before the phone number. When dialling, a pause will automatically be inserted after the Outside (CO) Line Access number.

System Password [002]

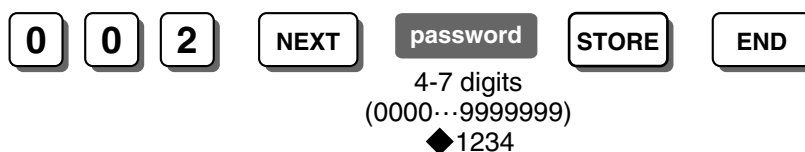

WARNING

To maintain system security, a password is required to perform system programming. To avoid unauthorised access and possible fraudulent dialling, do not disclose the password.

Warning to the Administrator regarding the system password

1. Please inform the customer of the importance of the password and the possible dangers if it becomes known to others.

2. To avoid unauthorised access and possible fraudulent dialling, maintain the secrecy of the password.
3. We strongly recommend that you change the default password value to something else for reasons of system security. It is best to use a password of 7 digits.
4. Please change the password periodically.
5. If a system password is forgotten, it can be found by loading a backup of the system data into a PC, and checking the password using the KX-TE308 Maintenance Console software. If you do not have a backup of the system data, you must reset the PBX to its factory defaults and reprogramme it. Therefore, we strongly recommend maintaining a backup of the system data. For more information on how to back up the system data, refer to the on-line help that appears by selecting the Help menu during PC programming. However, as system passwords can be extracted from backup copies of the system data file, do not allow unauthorised access to these files.

Note

This PBX has only one system password. It can be changed by either PT programming or PC programming. For this reason, the password can consist of numerals only.

Operator Assignment [008]



Note

To delete (disable) an extension jack number, press CLEAR in the extension jack number step.

Extension Number [009]

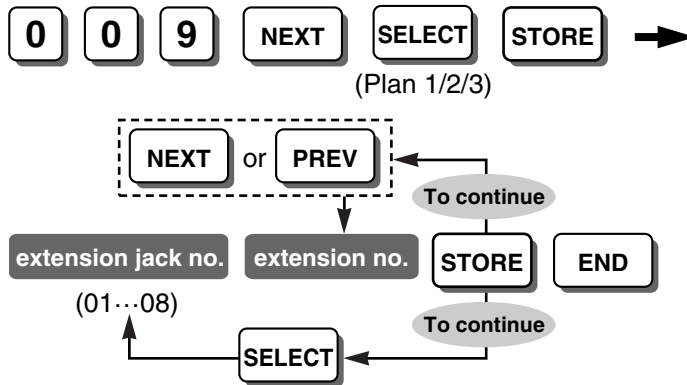

Notes

- Programmable extension numbers are as follows:
Plan 1: 100–199; Plan 2: 100–499; Plan 3: 10–49
(for United Kingdom/New Zealand: Plan 1: 200–299; for New Zealand: Plan 2: 200–499, Plan 3: 20–49)
- The same extension number cannot be entered for 2 different extension jacks.

System Speed Dialling Name [011]

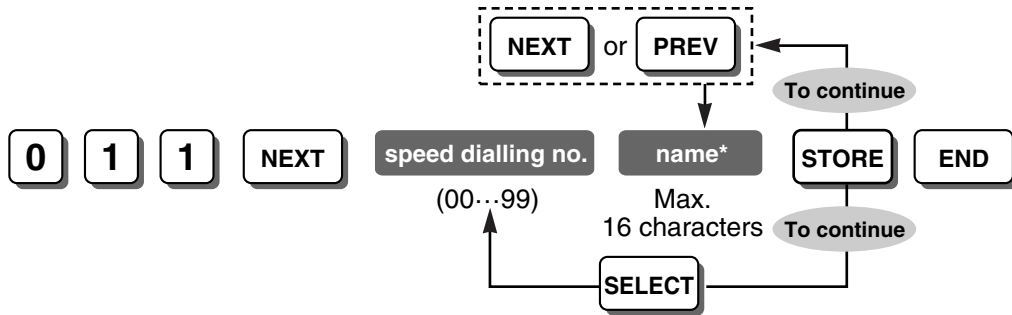

Note

* A name can be stored using a PT's dialling buttons. The displayed character varies depending on the number of times that the dialling button is pressed. It is possible to toggle between "Alphabet mode" and "Numeral mode" by pressing SELECT.

Automatic Line Access [121]



Note

* For New Zealand: 1 or 9

Dial Mode [401]

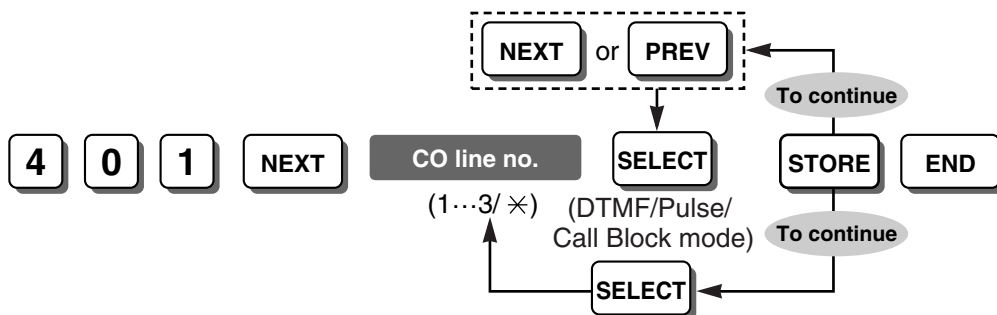

Pulse Speed [402]

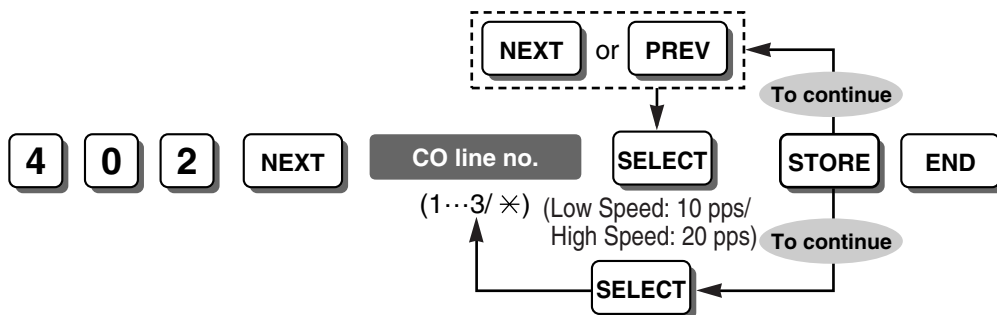

Extension Name [604]

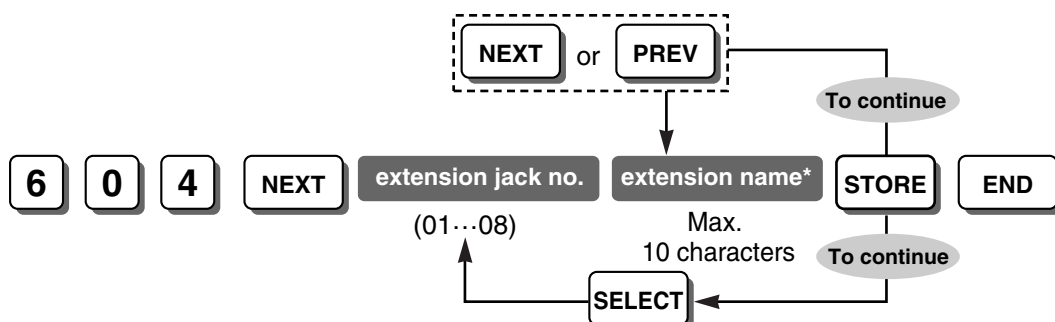

Note

* An extension name can be stored using a PT's dialling buttons. The displayed character varies depending on the number of times that the dialling button is pressed. It is possible to toggle between "Alphabet mode" and "Numeral mode" by pressing SELECT.

Extension Name in Cyrillic [616]

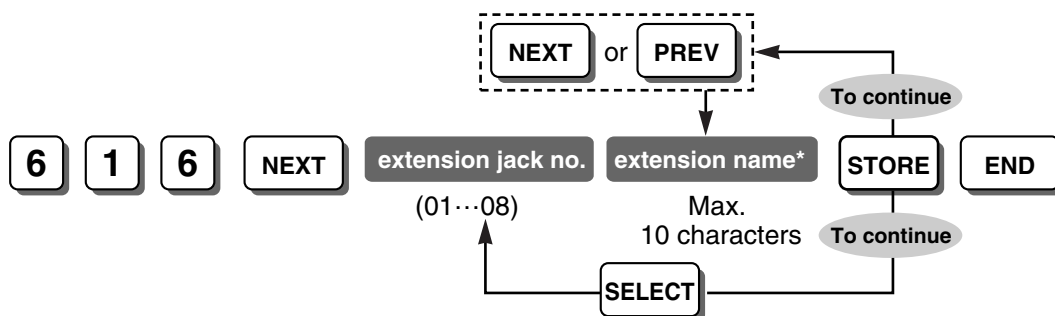

Notes

- * An extension name can be stored using a PT's dialling buttons. The displayed character varies depending on the number of times that the dialling button is pressed. It is possible to toggle between "Alphabet mode", "Cyrillic alphabet mode", and "Numeral mode" by pressing SELECT.
- Russian display is only available for the KX-T7730/KX-T7735RU.

Country [995]

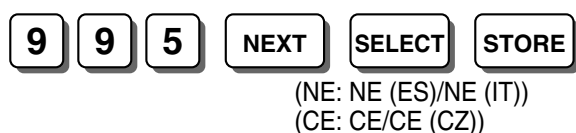

(NE: NE (ES)/NE (IT))
(CE: CE/CE (CZ))

Notes

- This programme specifies your country/area when the suffix of the PBX is "NE" or "CE". For more information, please consult your dealer.
- When the country code is changed, all system data is initialised.

5.2.2 Toll Restriction (TRS) Features

Toll Restriction (TRS) can prohibit certain extension users from making unauthorised outside (CO) line calls. Every extension is assigned to one of 5 classes of service (COSs) for each time service mode (TRS-COS—Day/Night/Lunch [601-603]); COS 1 grants the highest level of authorisation, allowing all outside (CO) line calls to be made, and COS 5 grants the lowest level of authorisation. COSs 2 through 5 are used to restrict calls with a combination of preprogrammed Denied Code Table (→ TRS—COS 2-5 Denied Code [302-305]) and Exception Code Table (→ TRS—Exception Code [306]).

Applicable tables by COS

The Denied Code Tables and Exception Code Tables that apply to each COS are listed below.

COS No.	Denied Code Tables	Exception Code Tables
1	No restriction. (Not Programmable)	No restriction. (Not Programmable)
2	20 denied codes programmed in [302]. (Table for Class 2)	80 exception codes (code numbers 01–80) programmed in [306]. (Tables for Classes 2 through 5)
3	40 denied codes programmed in [302] and [303]. (Tables for Classes 2 and 3)	60 exceptions codes (code numbers 01–60) programmed in [306]. (Tables for Classes 3 through 5)
4	60 denied codes programmed in [302] through [304]. (Tables for Classes 2 through 4)	40 exception codes (code numbers 01–40) programmed in [306]. (Tables for Classes 4 and 5)
5	80 denied codes programmed in [302] through [305]. (Tables for Classes 2 through 5)	20 exception codes (code numbers 01–20) programmed in [306]. (Table for Class 5)

TRS-COS—Day/Night/Lunch [601-603]

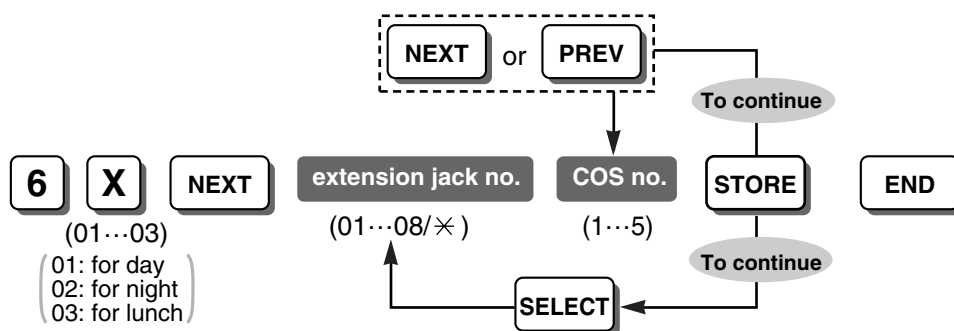

TRS—COS 2-5 Denied Code [302-305]

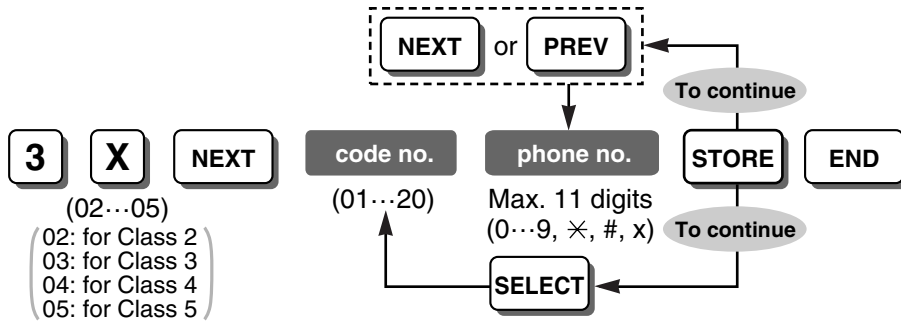

TRS—Exception Code [306]

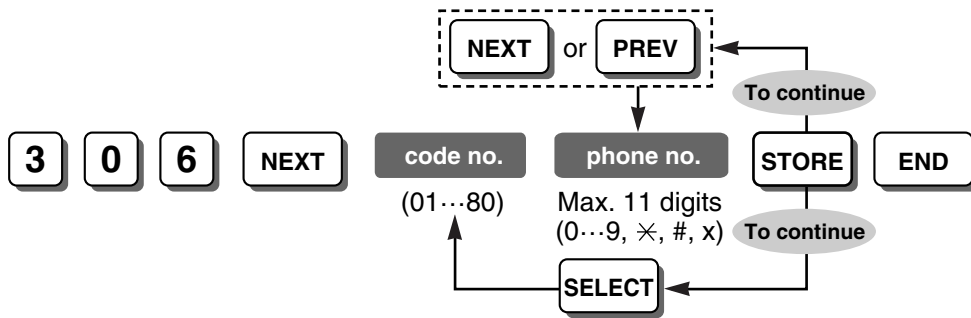







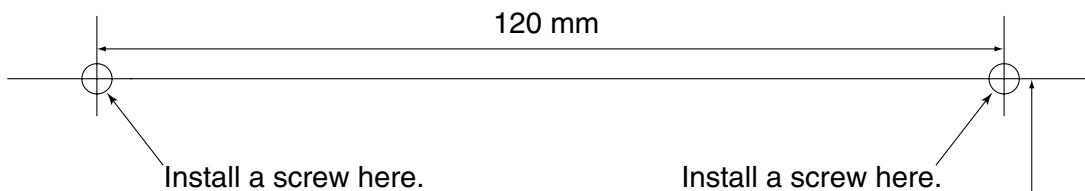

TEMPLATE FOR WALL MOUNTING

1. Copy or print this template and place it on the wall.
2. Install the screws as marked.
If you mount the main unit on a concrete or mortar wall, fit anchor plugs (not included) into the wall beforehand.
3. Hook the unit onto the screw heads.

Note

Make sure to set the print size to correspond with the size of this page. If the dimensions of the paper output still deviate slightly from the measurements indicated here, use the measurements indicated here.

232 mm

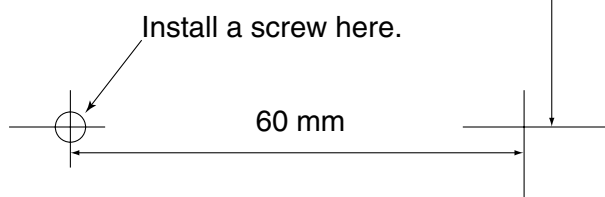

Electronic documentation for the KX-TEA308/KX-TEB308 can be found on the included CD-ROM.

To view this documentation, simply insert the CD-ROM into your PC—your default web browser will launch automatically and open the appropriate file.

To view the documentation manually, start by opening the file named "index.html" with your web browser.

Notes

- A web browser and a PDF viewer are required to view the included documentation. The Programming Tables is stored in Microsoft Excel 97 format.
- Microsoft Internet Explorer (5.5 or later) and Adobe® Reader® (6.0 or later) or Acrobat® Reader (4.0 or later) is recommended. Please visit the appropriate web site for information on software download and usage.

Includes:

- Documentation
 - Installation Manual/Feature Guide/User Manual/
 - Getting Started/Programming Tables/
 - Quick Reference Guide for Proprietary Telephone/
 - Quick Reference Guide for Single Line Telephone/
 - Visual Setup Guide (English only)
- KX-TE308 Maintenance Console
- USB Driver

Trademarks

- Microsoft and Windows are either registered trademarks or trademarks of Microsoft Corporation in the United States and/or other countries.
- Celeron and Intel are trademarks or registered trademarks of Intel Corporation or its subsidiaries in the United States and other countries.
- Adobe, Acrobat, and Reader are either registered trademarks or trademarks of Adobe Systems Incorporated in the United States and/or other countries.
- All other trademarks identified herein are the property of their respective owners.

 The KX-TEA308E, the KX-TEA308NE, the KX-TEA308GR, the KX-TEA308CE, and the KX-TEA308PD are designed to interwork with the Analogue Public Switched Telephone Network (PSTN) of European countries.

Panasonic Communications Co., Ltd./Panasonic Communications Company (U.K.) Ltd. declares that this equipment is in compliance with the essential requirements and other relevant provisions of Radio & Telecommunications Terminal Equipment (R&TTE) Directive 1999/5/EC.

Declarations of Conformity for the relevant Panasonic products described in this manual are available for download by visiting:

<http://doc.panasonic.de>

Contact:

Panasonic Services Europe GmbH
Panasonic Testing Centre
Winsbergring 15, 22525 Hamburg, F.R. Germany

Panasonic Communications Co., Ltd.

1-62, 4-chome, Minoshima, Hakata-ku, Fukuoka 812-8531, Japan

Copyright:

This material is copyrighted by Panasonic Communications Co., Ltd., and may be reproduced for internal use only. All other reproduction, in whole or in part, is prohibited without the written consent of Panasonic Communications Co., Ltd.